

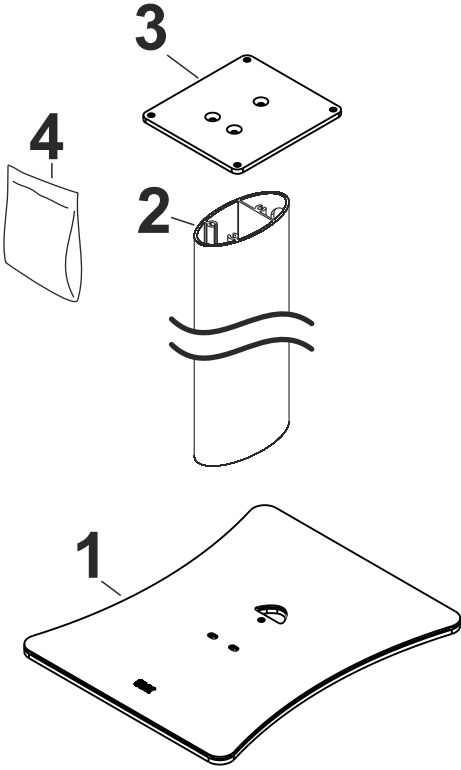











# Montageanleitung Assembly Instruction

## Lautsprecherständer ELAC LS 50 Loudspeaker Stand ELAC LS 50

Lieferumfang / Scope of delivery					
	Bild / pic.	Nr./ No.	Anzahl / No. of pieces	Beschreibung	Description
		1	2	Grundplatte	Base plate
		2	2	Säule	Column
		3	2	Montageplatte	Top plate
		4	1	Zubehör Set	Accessory set
		A	6	Senkkopfschraube, M6 x 20	Counter-sunk screw, M6 x 20
		B	6	Linsenkopfschraube, M6 x 20	Lens head screw, M6 x 20
		C	8	Dämpfungs-Pad	Top pad
		D	8	Klettpad	Velcro-pad
		E	8	Gewindeschraube, M5 x 12	Slotted pan head screw, M5 x 12
		F	8	Spike	Spike
		G	8	Kontermutter, M8	Lock nut, M8
		H	8	Spike-Unterlegscheibe	Spike floor protector
		I	1	Innensechskantschlüssel, 3 mm	Hexagone wrench, 3 mm
		K	1	Innensechskantschlüssel, 4 mm	Hexagone wrench, 4 mm
	M	1	Maulschlüssel, SW 13	Wrench, size: 13 mm	

ELAC Electroacoustic GmbH  
Fraunhoferstraße 16, 24118 Kiel  
Tel. 0431/64 774-0, Fax 0431/682101

[www.elac.com](http://www.elac.com)

02 1005 5328 / 362149

**ELAC** The life of sound.

**1.**  
Montieren Sie die Montageplatte (3) mit Hilfe der Schrauben (A) auf die Säule (2).

*Assemble top plate (3) to column (2) by means of screws (A).*

Montieren Sie die Grundplatte (1) mit Hilfe der Schrauben (B) auf die Säule (2).

*Assemble bottom plate (1) to column (2) by means of screws (B).*

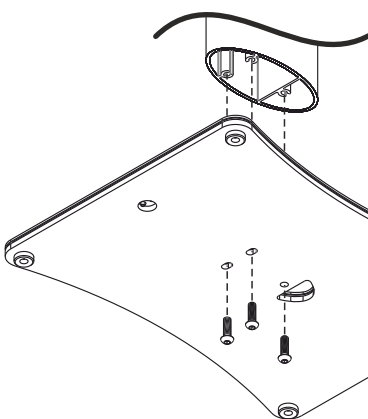
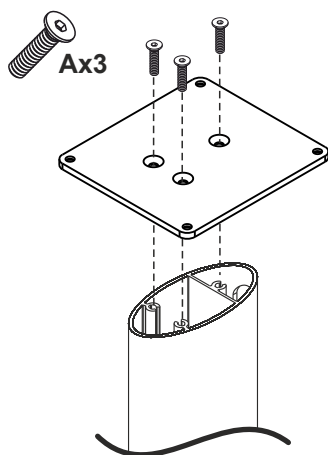

**2.**  
Kleben Sie die Dämpfungs-Pads gemäß Zeichnung auf.

*Attach top pads as shown.*

Sichern Sie Ihren Lautsprecher ggf. mit Hilfe der Klett pads (D), jeweils 1x Filz- und 1x Hakenseite.

*Attach Velcro-pads to loudspeaker if required, 1x loops, 1x hooks.*

Wenn Ihr Lautsprecher eine Einschlagmutter im Gehäuseboden besitzt, nutzen Sie bitte Schraube (E) zur Sicherung.

*If your loudspeaker has a nut, please use bolt (E).*

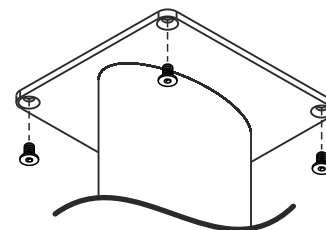
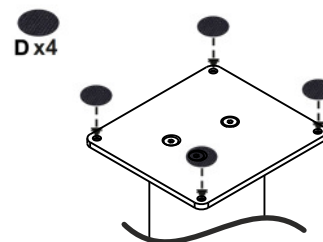
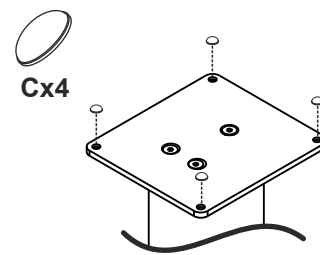

**3.**  
Montieren und Justieren Sie die Spikes (F).

*Attach and adjust base spikes (F).*

**Anmerkung:**

Wenn Sie einen empfindlichen Fußboden (z.B. Parkett) besitzen, sollten Sie die Spike-Unterlegscheiben (H) nutzen.

**Note:**

*In case you have a sensitive floor surface (like hardwood or tiles) which could be damaged by the spikes, please use the spike plates included in the kit (H).*

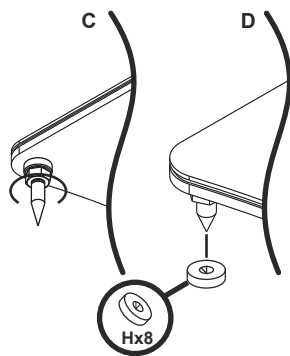
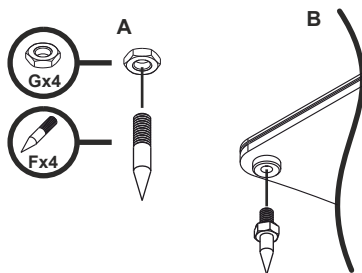

**4.**  
Kabelverlegung...

*Cable management...*

